

JJRZ52-5.16HP

DATA SHEET

TRUCK MOUNTED BOOM PUMP



52M Truck Mounted Boom Pump with 158m³/h Output & Roll-Z Type Boom Design

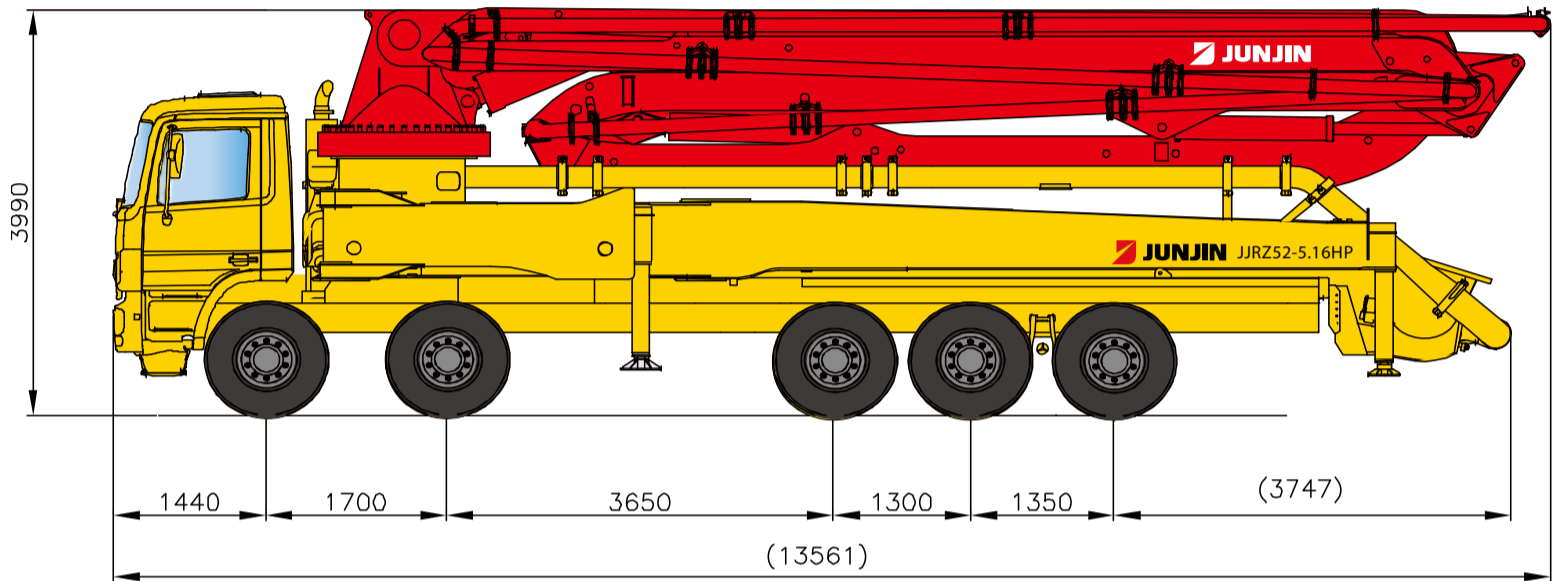

* Remark : Standard specification with MB4141. Dimension depends on truck specification.

TECHNICAL SPECIFICATION

GENERAL SPECIFICATION		PUMP SPECIFICATION			BOOM SPECIFICATION	
Delivery Line	DN 125 / 5"	Output	Rod	158 m ³ /h	Number of booms	5 Sections
Radio remote	Proportional control		Piston	98 m ³ /h	Folding Type	R & Z Type
Wear plate / Ring	Tungsten Carbide	Pressure	Rod	72 Bar	Vertical Height	51.7 m
Water Pump	20 Bar		Piston	115 Bar	Horizontal Reach	47.7 m
Water Tank	500 Liter	Delivery Cylinder (Hard-chromed)	Φ230 mm		Unfolding height	10.3 m
Auto Lubrication	Hyd. grease, Hopper	Stroke Length	2100 mm		End-Hose Length	4.0 m
		S-Valve	8" X 7"		1st Section	9.9 m
		Main Oil Pump	Rexroth Hydromatic		2nd Section	8.65 m
		System Pressure	350 Bar		3rd Section	8.8m
		Switching Type	Hydraulic		4th Section	9.8 m
		Hopper Capacity	600 Liter		5th Section	10.55 m

* All technical data are theoretical values and Specification are subject to change without prior notice.
 * www.junjin.com

JJRZ52-5.16HP

DATA SHEET

TRUCK MOUNTED BOOM PUMP



52M Truck Mounted Boom Pump with 158m³/h Output & Roll-Z Type Boom Design

BOOM WORKING DIAGRAM

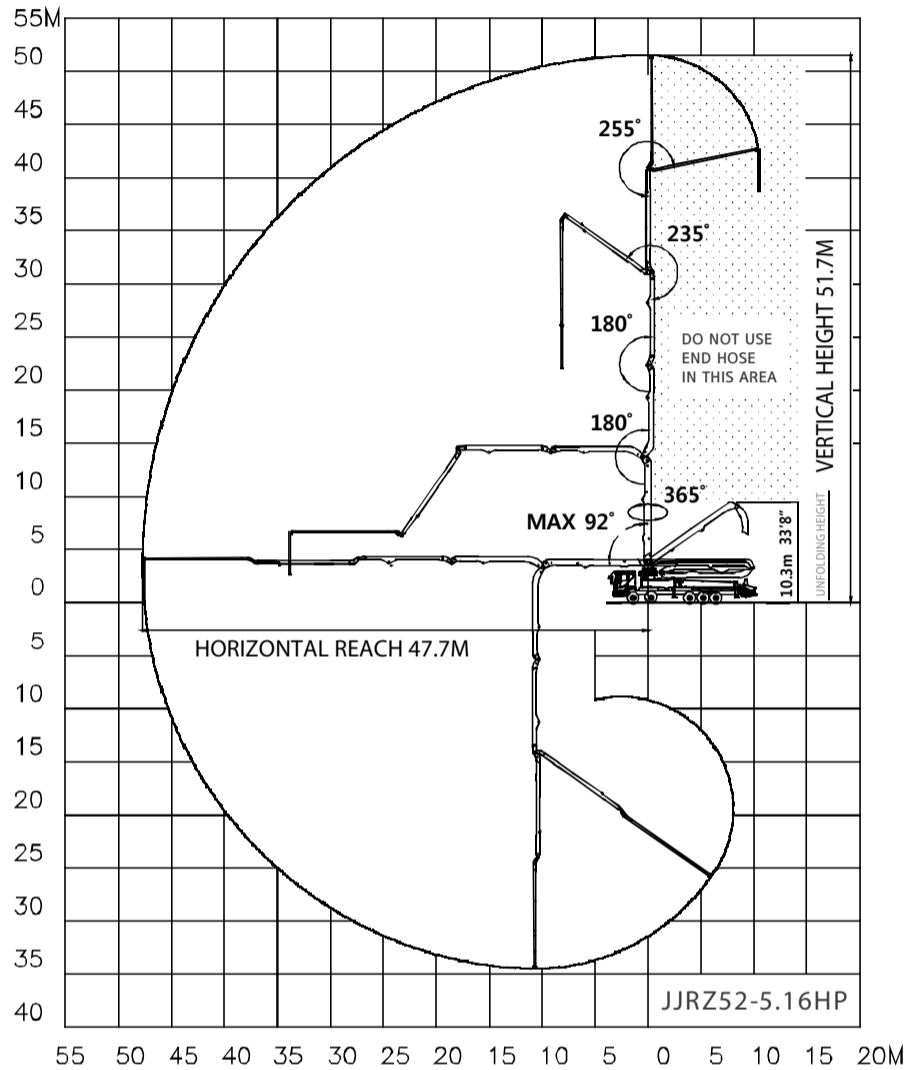

OUTRIGGER SPAN

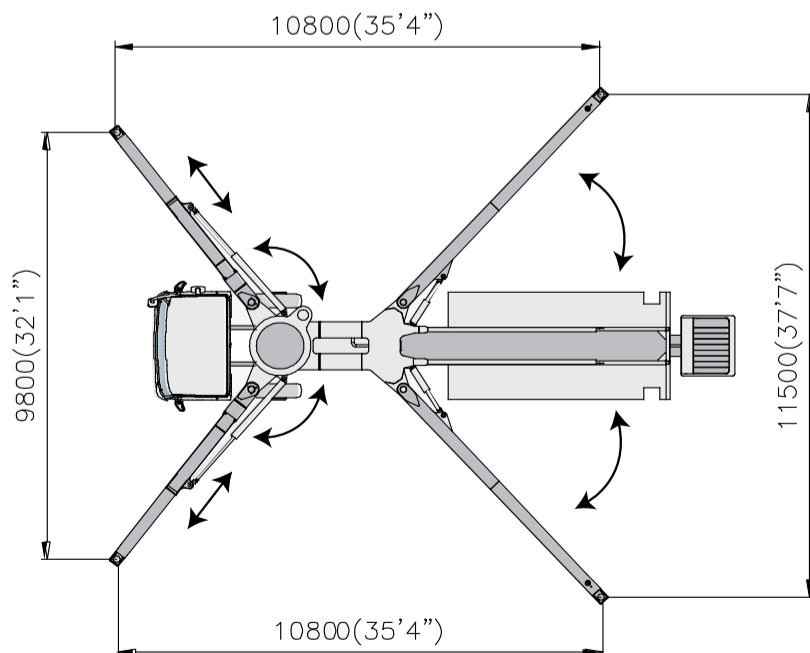

* All technical data are theoretical values and Specification are subject to change without prior notice.
* www.junjin.com